

# User Manual



## **1KVA-5KVA (PF1) INVERTER / CHARGER**

# Table Of Contents

<b>ABOUT THIS MANUAL .....</b>	<b>1</b>
Purpose.....	1
Scope.....	1
<b>SAFETY INSTRUCTIONS.....</b>	<b>1</b>
<b>INTRODUCTION .....</b>	<b>2</b>
Features.....	2
Basic System Architecture .....	2
Product Overview.....	3
<b>INSTALLATION .....</b>	<b>4</b>
Unpacking and Inspection.....	4
Preparation .....	4
Mounting the Unit.....	4
Battery Connection .....	5
AC Input/Output Connection.....	7
PV Connection .....	8
Final Assembly.....	9
Communication Connection.....	10
Dry Contact Signal .....	10
<b>OPERATION .....</b>	<b>11</b>
Power ON/OFF .....	11
Operation and Display Panel .....	11
LCD Display Icons .....	12
LCD Setting.....	14
Display Setting .....	25
Operating Mode Description .....	28
Fault Reference Code.....	29
Warning Indicator.....	30
<b>BATTERY EQUALIZATION .....</b>	<b>31</b>
<b>SPECIFICATIONS .....</b>	<b>33</b>
Table 1 Line Mode Specifications .....	33
Table 2 Inverter Mode Specifications .....	34
Table 3 Charge Mode Specifications .....	35
<b>TROUBLE SHOOTING.....</b>	<b>37</b>

# ABOUT THIS MANUAL

## Purpose

This manual describes the assembly, installation, operation and troubleshooting of this unit. Please read this manual carefully before installations and operations. Keep this manual for future reference.

## Scope

This manual provides safety and installation guidelines as well as information on tools and wiring.

# SAFETY INSTRUCTIONS



**WARNING: This chapter contains important safety and operating instructions. Read and keep this manual for future reference.**

1. Before using the unit, read all instructions and cautionary markings on the unit, the batteries and all appropriate sections of this manual.
2. **CAUTION** --To reduce risk of injury, charge only deep-cycle lead acid type rechargeable batteries. Other types of batteries may burst, causing personal injury and damage.
3. Do not disassemble the unit. Take it to a qualified service center when service or repair is required. Incorrect re-assembly may result in a risk of electric shock or fire.
4. To reduce risk of electric shock, disconnect all wirings before attempting any maintenance or cleaning. Turning off the unit will not reduce this risk.
5. **CAUTION** – Only qualified personnel can install this device with battery.
6. **NEVER** charge a frozen battery.
7. For optimum operation of this inverter/charger, please follow required spec to select appropriate cable size. It's very important to correctly operate this inverter/charger.
8. Be very cautious when working with metal tools on or around batteries. A potential risk exists to drop a tool to spark or short circuit batteries or other electrical parts and could cause an explosion.
9. Please strictly follow installation procedure when you want to disconnect AC or DC terminals. Please refer to INSTALLATION section of this manual for the details.
10. Fuses (3 pieces of 40A, 32VDC for 1KVA, 4 pieces of 40A, 32VDC for 2KVA and 6 pieces for 3KVA, 1 piece of 200A, 58VDC for 4KVA and 5KVA) are provided as over-current protection for the battery supply.
11. **GROUNDING INSTRUCTIONS** -This inverter/charger should be connected to a permanent grounded wiring system. Be sure to comply with local requirements and regulation to install this inverter.
12. **NEVER** cause AC output and DC input short circuited. Do NOT connect to the mains when DC input short circuits.
13. **Warning!!** Only qualified service persons are able to service this device. If errors still persist after following troubleshooting table, please send this inverter/charger back to local dealer or service center for maintenance.

# INTRODUCTION

This is a multi-function inverter/charger, combining functions of inverter, MPPT solar charger and battery charger to offer uninterruptible power support with portable size. Its comprehensive LCD display offers user-configurable and easy-accessible button operation such as battery charging current, AC/solar charger priority, and acceptable input voltage based on different applications.

## Features

- Pure sine wave inverter
- Built-in MPPT solar charge controller
- Configurable input voltage range for home appliances and personal computers via LCD setting
- Configurable battery charging current based on applications via LCD setting
- Configurable AC/Solar Charger priority via LCD setting
- Compatible to mains voltage or generator power
- Auto restart while AC is recovering
- Overload/ Over temperature/ short circuit protection
- Smart battery charger design for optimized battery performance
- Cold start function

## Basic System Architecture

The following illustration shows basic application for this inverter/charger. It also includes following devices to have a complete running system:

- Generator or Utility.
- PV modules (option)

Consult with your system integrator for other possible system architectures depending on your requirements.

This inverter can power all kinds of appliances in home or office environment, including motor-type appliances such as tube light, fan, refrigerator and air conditioner.

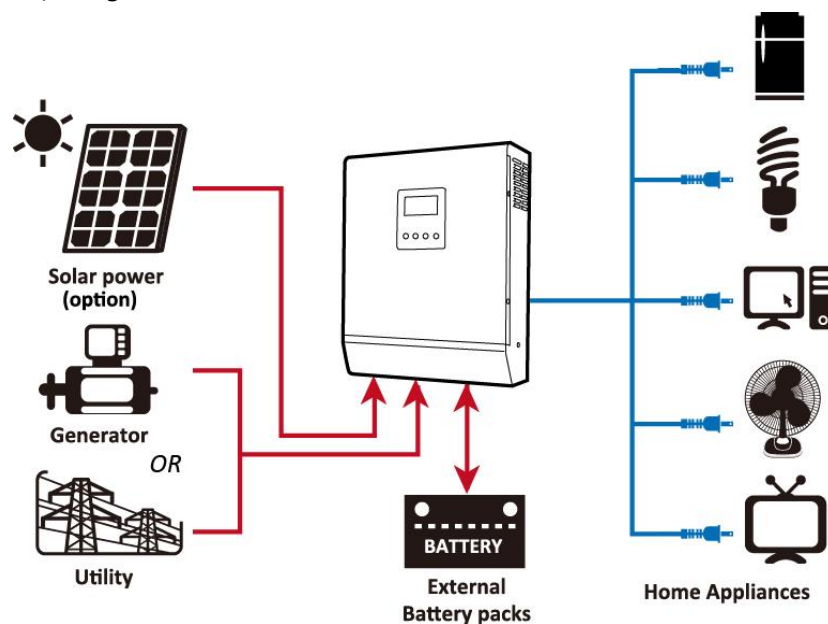
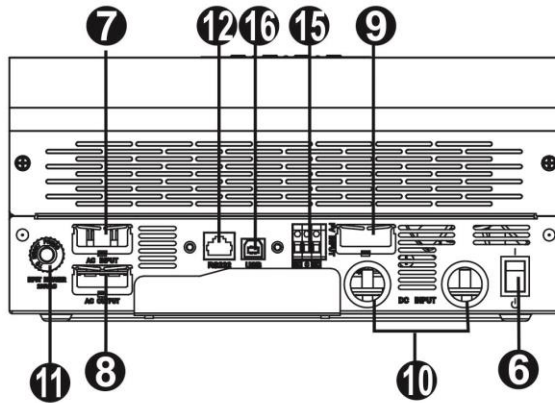
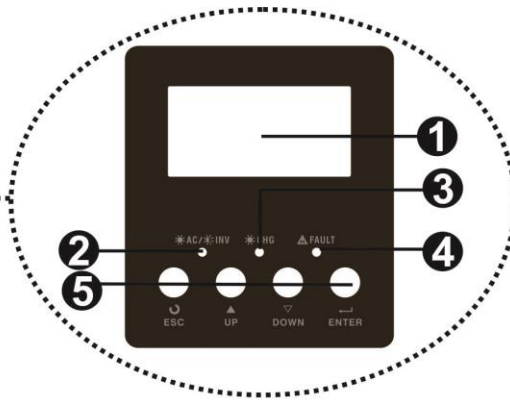
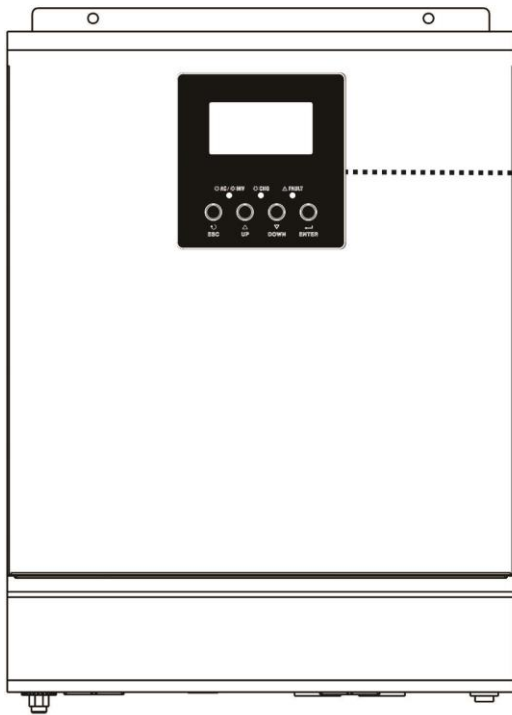
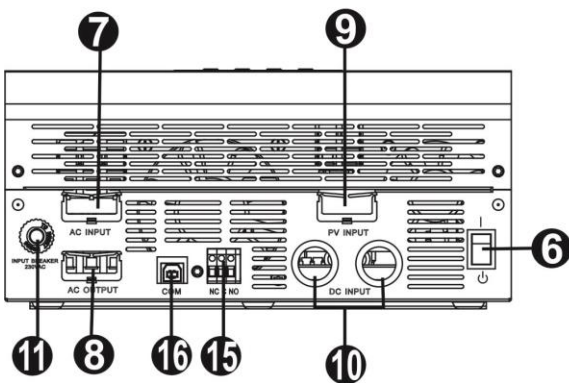

Figure 1 Hybrid Power System

# Product Overview



**4KVA/5KVA single model**



**1-3KVA model**

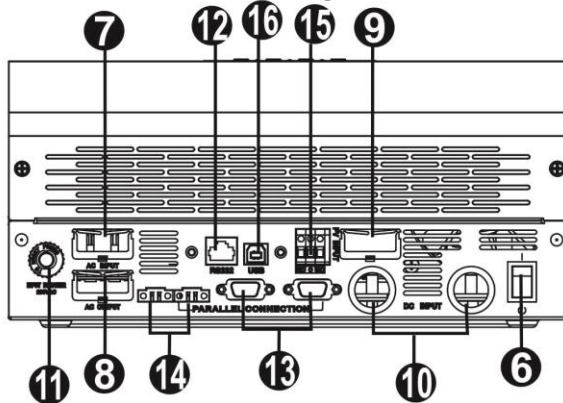

**4KVA/5KVA parallel model**

**NOTE:** For parallel model installation and operation, please check separate parallel installation guide for the details.

1. LCD display
2. Status indicator
3. Charging indicator
4. Fault indicator
5. Function buttons
6. Power on/off switch
7. AC input
8. AC output
9. PV input
10. Battery input
11. Circuit breaker
12. RS232 communication port
13. Parallel communication cable (only for parallel model)
14. Current sharing cable (only for parallel model)
15. Dry contact
16. USB communication port

# INSTALLATION

## Unpacking and Inspection

Before installation, please inspect the unit. Be sure that nothing inside the package is damaged. You should have received the following items inside of package:

- The unit x 1
- User manual x 1
- Communication cable x 1
- Software CD x 1

## Preparation

Before connecting all wirings, please take off bottom cover by removing two screws as shown below.

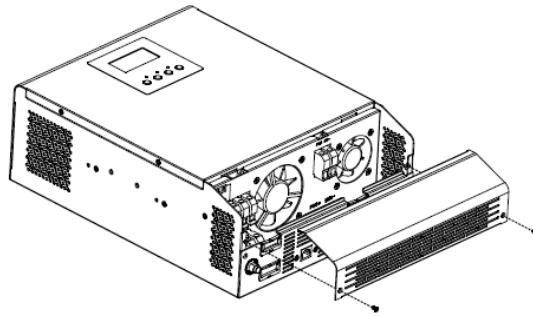

## Mounting the Unit

Consider the following points before selecting where to install:

- Do not mount the inverter on flammable construction materials.
- Mount on a solid surface
- Install this inverter at eye level in order to allow the LCD display to be read at all times.
- The ambient temperature should be between 0°C and 55°C to ensure optimal operation.
- The recommended installation position is to be adhered to the wall vertically.
- Be sure to keep other objects and surfaces as shown in the right diagram to guarantee sufficient heat dissipation and to have enough space for removing wires.

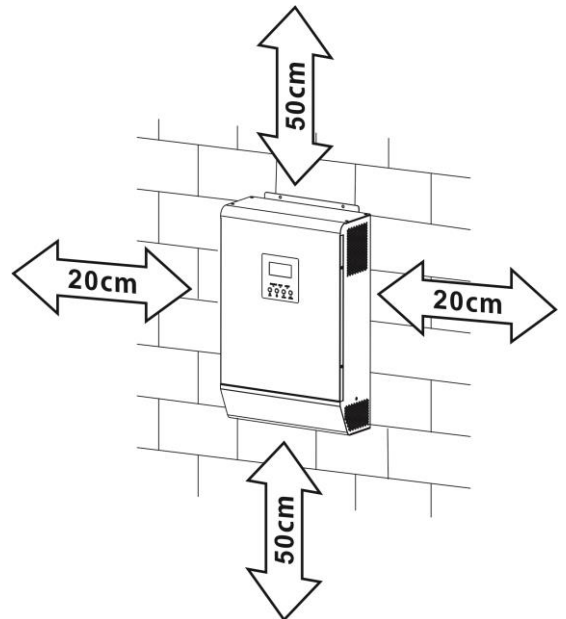

**SUITABLE FOR MOUNTING ON CONCRETE OR OTHER NON-COMBUSTIBLE SURFACE ONLY.**

Install the unit by screwing three screws. It's recommended to use M4 or M5 screws.

**1KVA 12V, 1-3KVA 24V,**

**1KVA/3KVA/4KVA/5KVA 48V model**

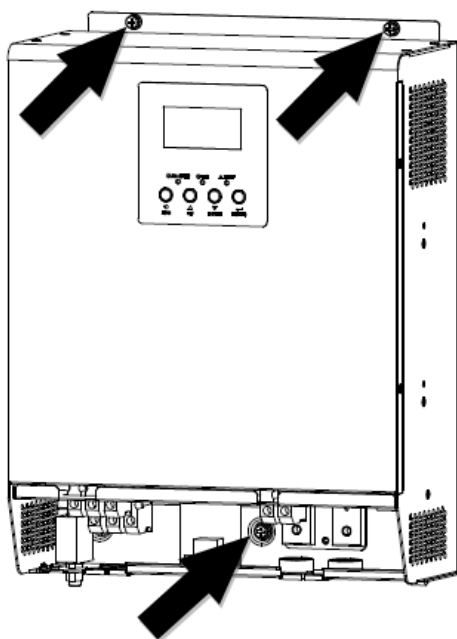

**2-3KVA 24V/48V Plus model**

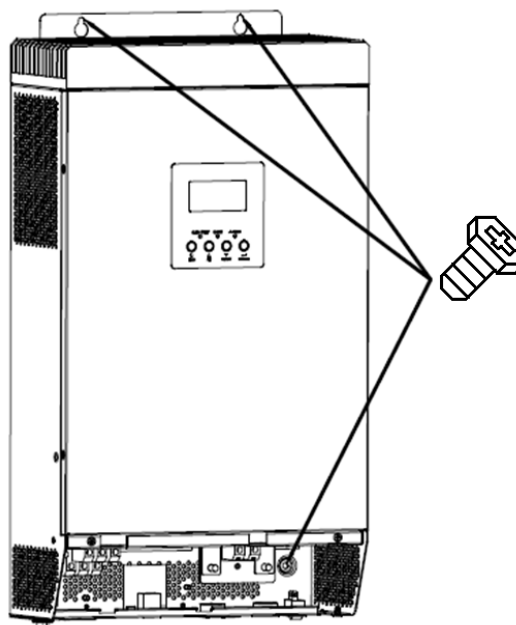

## Battery Connection

**CAUTION:** For safety operation and regulation compliance, it's requested to install a separate DC over-current protector or disconnect device between battery and inverter. It may not be requested to have a disconnect device in some applications, however, it's still requested to have over-current protection installed. Please refer to typical amperage in below table as required fuse or breaker size.

**WARNING!** All wiring must be performed by a qualified personnel.

**WARNING!** It's very important for system safety and efficient operation to use appropriate cable for battery connection. To reduce risk of injury, please use the proper recommended cable and terminal size as below.

**Ring terminal:**

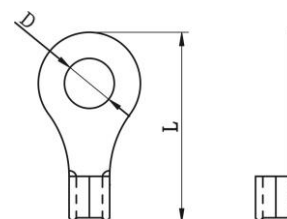

**Recommended battery cable and terminal size:**

Model	Maximum Amperage	Battery capacity	Wire Size	Ring Terminal		Torque value
				Cable mm <sup>2</sup>	Dimensions D (mm) L (mm)	
1KVA/2KVA	109A	100AH	1*4AWG	22	6.4 29.2	2~ 3 Nm
			2*8AWG	16	6.4 23.8	
3KVA	164A	100AH 200AH	1*2AWG	38	6.4 33.2	2~ 3 Nm
			2*6AWG	28	6.4 29.2	
4KVA	110A	200AH	1*4AWG	22	6.4 39.2	2~ 3 Nm
			2*8AWG	16	6.4 33.2	
5KVA	137A	200AH	1*2AWG	38	6.4 39.2	2~ 3 Nm
			2*6AWG	28	6.4 33.2	

Please follow below steps to implement battery connection:

1. Assemble battery ring terminal based on recommended battery cable and terminal size.
2. Connect all battery packs as units requires. It's suggested to connect at least 100Ah capacity battery for 1-3KVA model and at least 200Ah capacity battery for 4KVA/5KVA model.
3. Insert the ring terminal of battery cable flatly into battery connector of inverter and make sure the bolts are tightened with torque of 2-3 Nm. Make sure polarity at both the battery and the inverter/charge is correctly connected and ring terminals are tightly screwed to the battery terminals.

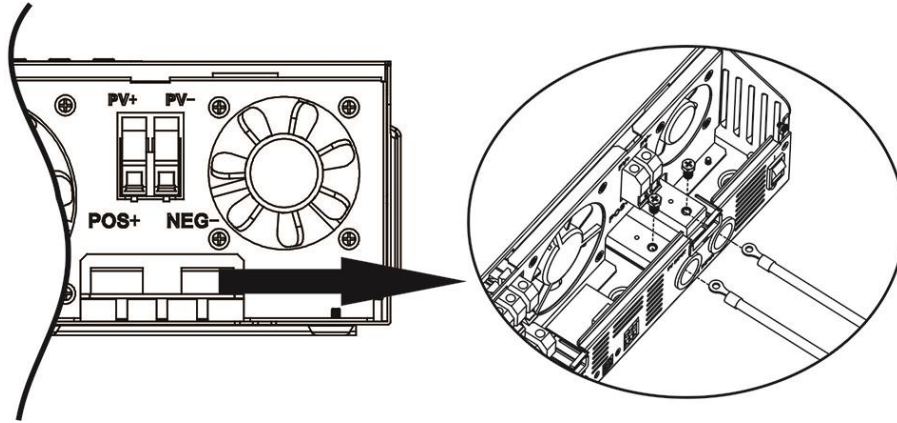

**WARNING: Shock Hazard**

Installation must be performed with care due to high battery voltage in series.



**CAUTION!!** Do not place anything between the flat part of the inverter terminal and the ring terminal. Otherwise, overheating may occur.

**CAUTION!!** Do not apply anti-oxidant substance on the terminals before terminals are connected tightly.

**CAUTION!!** Before making the final DC connection or closing DC breaker/disconnector, be sure positive (+) must be connected to positive (+) and negative (-) must be connected to negative (-).



## AC Input/Output Connection

**CAUTION!!** Before connecting to AC input power source, please install a **separate** AC breaker between inverter and AC input power source. This will ensure the inverter can be securely disconnected during maintenance and fully protected from over current of AC input. The recommended spec of AC breaker is 10A for 1KVA, 20A for 2KVA, 32A for 3KVA, 40A for 4KVA and 50A for 5KVA.

**CAUTION!!** There are two terminal blocks with "IN" and "OUT" markings. Please do NOT mis-connect input and output connectors.

**WARNING!** All wiring must be performed by a qualified personnel.

**WARNING!** It's very important for system safety and efficient operation to use appropriate cable for AC input connection. To reduce risk of injury, please use the proper recommended cable size as below.

### Suggested cable requirement for AC wires

Model	Gauge	Torque Value
1KVA	16 AWG	0.5~ 0.6 Nm
2KVA	14 AWG	0.8~ 1.0 Nm
3KVA	12 AWG	1.2~ 1.6 Nm
4KVA	10 AWG	1.4~ 1.6Nm
5KVA	8 AWG	1.4~ 1.6Nm

Please follow below steps to implement AC input/output connection:

1. Before making AC input/output connection, be sure to open DC protector or disconnecter first.
2. Remove insulation sleeve 10mm for six conductors. And shorten phase L and neutral conductor N 3 mm.
3. Insert AC input wires according to polarities indicated on terminal block and tighten the terminal screws. Be sure to connect PE protective conductor (⊕) first.

- ⊕ → **Ground (yellow-green)**
- ⊖ → **L→LINE (brown or black)**
- ⊖ → **N→Neutral (blue)**

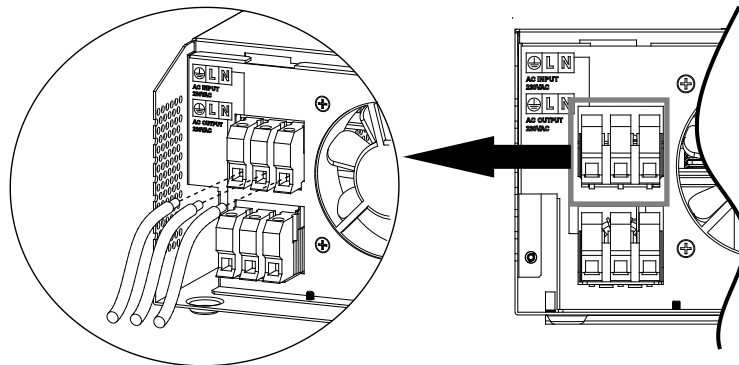

#### **WARNING:**

Be sure that AC power source is disconnected before attempting to hardwire it to the unit.

4. Then, insert AC output wires according to polarities indicated on terminal block and tighten terminal screws. Be sure to connect PE protective conductor (⊕) first.

- ⊕ → **Ground (yellow-green)**
- ⊖ → **L→LINE (brown or black)**
- ⊖ → **N→Neutral (blue)**

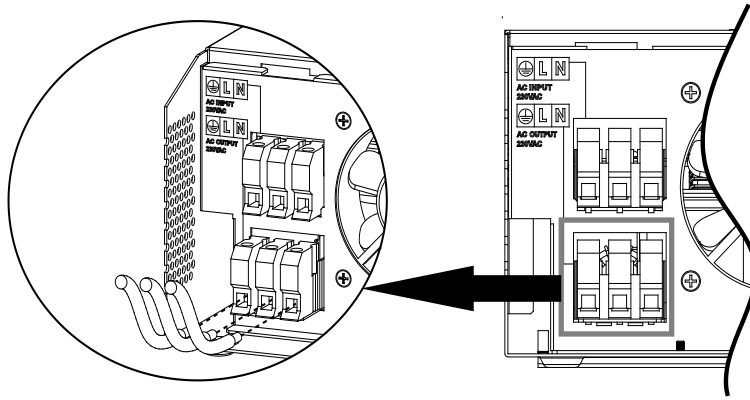

5. Make sure the wires are securely connected.

**CAUTION: Important**

Be sure to connect AC wires with correct polarity. If L and N wires are connected reversely, it may cause utility short-circuited when these inverters are worked in parallel operation.

**CAUTION:** Appliances such as air conditioner are required at least 2~3 minutes to restart because it's required to have enough time to balance refrigerant gas inside of circuits. If a power shortage occurs and recovers in a short time, it will cause damage to your connected appliances. To prevent this kind of damage, please check manufacturer of air conditioner if it's equipped with time-delay function before installation. Otherwise, this inverter/charger will trig overload fault and cut off output to protect your appliance but sometimes it still causes internal damage to the air conditioner.

**PV Connection**

**CAUTION:** Before connecting to PV modules, please install **separately** a DC circuit breaker between inverter and PV modules.

**WARNING!** All wiring must be performed by a qualified personnel.

**WARNING!** It's very important for system safety and efficient operation to use appropriate cable for PV module connection. To reduce risk of injury, please use the proper recommended cable size as below.

Model	Typical Amperage	Cable Size	Torque
1KVA 12V	40A	10 AWG	1.2~1.6 Nm
1KVA 24V / 2KVA 24V/ 3KVA 24V	25A	12 AWG	1.2~1.6 Nm
1KVA 48V / 3KVA 48V	18A	14 AWG	1.2~1.6 Nm
2KVA 24V Plus 3KVA 24V Plus 2KVA 48V Plus 3KVA 48V Plus	60A	8 AWG	1.4~1.6 Nm
4KVA / 5KVA	80A	6 AWG	1.4~1.6 Nm

**PV Module Selection:**

When selecting proper PV modules, please be sure to consider below parameters:

1. Open circuit Voltage (Voc) of PV modules not exceeds max. PV array open circuit voltage of inverter.
2. Open circuit Voltage (Voc) of PV modules should be higher than min. battery voltage.

Solar Charging Mode					
INVERTER MODEL	1KVA 12V	1KVA 24V 2KVA 24V 3KVA 24V	1KVA 48V 3KVA 48V	2KVA 24V Plus/ 3KVA 24V Plus	2KVA 48V Plus/ 3KVA 48V Plus/ 4KVA/5KVA
Max. PV Array Open Circuit Voltage	102Vdc max	75Vdc max	102Vdc max	145Vdc	
PV Array MPPT Voltage Range	15~80Vdc	30~66Vdc	60~88Vdc	30~115Vdc	60~115Vdc
Min. battery voltage for PV charge	8.5Vdc	17Vdc	34Vdc	17Vdc	34Vdc

Please follow below steps to implement PV module connection:

1. Remove insulation sleeve 10 mm for positive and negative conductors.
2. Check correct polarity of connection cable from PV modules and PV input connectors. Then, connect positive pole (+) of connection cable to positive pole (+) of PV input connector. Connect negative pole (-) of connection cable to negative pole (-) of PV input connector.

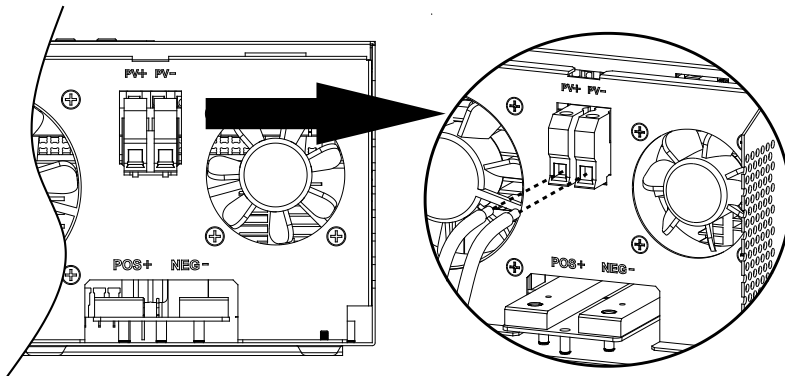
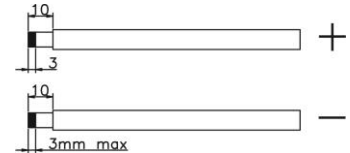

3. Make sure the wires are securely connected.

**Final Assembly**

After connecting all wirings, please put bottom cover back by screwing two screws as shown below.

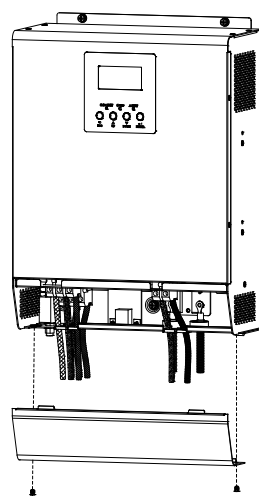

1KVA/2KVA/3KVA/4KVA/5KVA

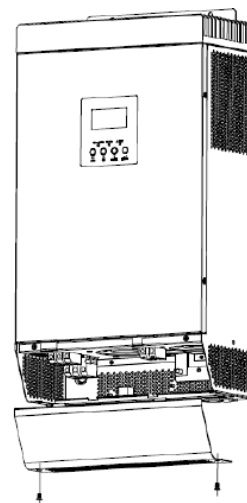

2KVA Plus/3KVA Plus

## Communication Connection

Please use supplied communication cable to connect to inverter and PC. Insert bundled CD into a computer and follow on-screen instruction to install the monitoring software. For the detailed software operation, please check user manual of software inside of CD.

## Dry Contact Signal

There is one dry contact (3A/250VAC) available on the rear panel. When program 38 is set as "disable", it could be used to deliver signal to external device when battery voltage reaches warning level. When program 38 is set as "enable" and the unit is working in battery mode, it could be used to trigger the grounding box to connect neutral and grounding of AC output together.

When program 38 is set as "disable" (default setting):

Unit Status	Condition		Dry contact port: 		
			NC & C	NO & C	
Power Off	Unit is off and no output is powered.		Close	Open	
Power On	Output is powered from Utility.		Close	Open	
	Output is powered from Battery or Solar.	Program 01 set as Utility	Battery voltage < Low DC warning voltage	Open	Close
			Battery voltage > Setting value in Program 13 or battery charging reaches floating stage	Close	Open
	Output is powered from Battery or Solar.	Program 01 is set as SBU or Solar first	Battery voltage < Setting value in Program 12	Open	Close
Battery voltage > Setting value in Program 13 or battery charging reaches floating stage			Close	Open	

When program 38 is set as "enable":

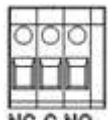
Unit Status	Condition		Dry contact port: 	
			NC & C	NO & C
Power Off	Unit is off and no output is powered.		Close	Open
Power On	Unit works in standby mode, line mode or fault mode		Close	Open
	Unit works in battery mode or power saving mode		Open	Close

# OPERATION

## Power ON/OFF

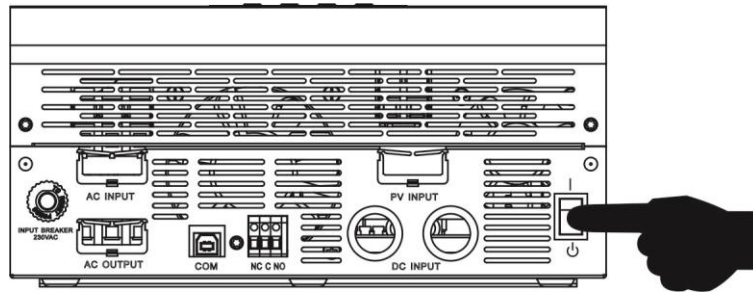

Once the unit has been properly installed and the batteries are connected well, simply press On/Off switch (located on the button of the case) to turn on the unit.

## Operation and Display Panel

The operation and display panel, shown in below chart, is on the front panel of the inverter. It includes three indicators, four function keys and a LCD display, indicating the operating status and input/output power information.

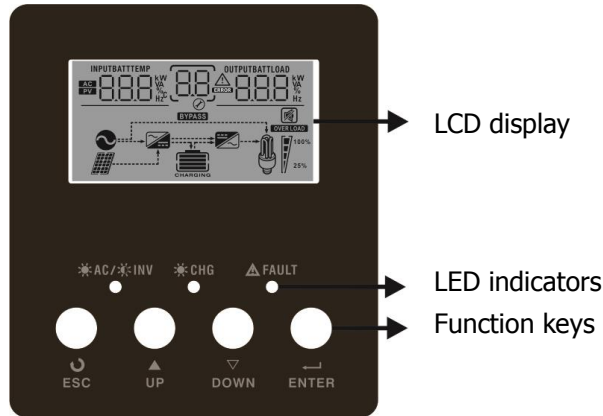

### LED Indicator

LED Indicator		Messages	
☀ AC / ☀ INV	Green	Solid On	Output is powered by utility in Line mode.
		Flashing	Output is powered by battery or PV in battery mode.
☀ CHG	Green	Solid On	Battery is fully charged.
		Flashing	Battery is charging.
⚠ FAULT	Red	Solid On	Fault occurs in the inverter.
		Flashing	Warning condition occurs in the inverter.

### Function Keys

Function Key	Description
ESC	To exit setting mode
UP	To go to previous selection
DOWN	To go to next selection
ENTER	To confirm the selection in setting mode or enter setting mode

# LCD Display Icons

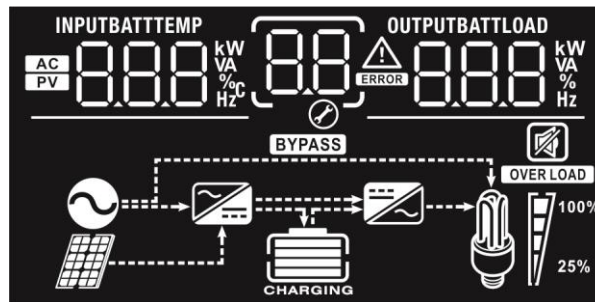

Icon	Function description	
<b>Input Source Information</b>		
	Indicates the AC input.	
	Indicates the PV input	
	Indicate input voltage, input frequency, PV voltage, battery voltage and charger current.	
<b>Configuration Program and Fault Information</b>		
	Indicates the setting programs.	
	Indicates the warning and fault codes.	
	Warning:  flashing with warning code.	
	Fault:  lighting with fault code	
<b>Output Information</b>		
	Indicate output voltage, output frequency, load percent, load in VA, load in Watt and discharging current.	
<b>Battery Information</b>		
	Indicates battery level by 0-24%, 25-49%, 50-74% and 75-100% in battery mode and charging status in line mode.	
In AC mode, it will present battery charging status.		
Status	Battery voltage	LCD Display
Constant Current mode / Constant Voltage mode	<2V/cell	4 bars will flash in turns.
	2 ~ 2.083V/cell	Bottom bar will be on and the other three bars will flash in turns.
	2.083 ~ 2.167V/cell	Bottom two bars will be on and the other two bars will flash in turns.
Floating mode. Batteries are fully charged.	> 2.167 V/cell	Bottom three bars will be on and the top bar will flash.
		4 bars will be on.

In battery mode, it will present battery capacity.

Load Percentage	Battery Voltage	LCD Display
Load > 50%	< 1.717V/cell	
	1.717V/cell ~ 1.8V/cell	
	1.8 ~ 1.883V/cell	
	> 1.883 V/cell	
50% > Load > 20%	< 1.817V/cell	
	1.817V/cell ~ 1.9V/cell	
	1.9 ~ 1.983V/cell	
	> 1.983	
Load < 20%	< 1.867V/cell	
	1.867V/cell ~ 1.95V/cell	
	1.95 ~ 2.033V/cell	
	> 2.033	

### Load Information

	Indicates overload.			
	Indicates the load level by 0-24%, 25-49%, 50-74% and 75-100%.			
	0%~24%	25%~49%	50%~74%	75%~100%

### Mode Operation Information

	Indicates unit connects to the mains.
	Indicates unit connects to the PV panel.
	Indicates load is supplied by utility power.
	Indicates the utility charger circuit is working.
	Indicates the DC/AC inverter circuit is working.

### Mute Operation

	Indicates unit alarm is disabled.
--	-----------------------------------

## LCD Setting

After pressing and holding ENTER button for 3 seconds, the unit will enter setting mode. Press "UP" or "DOWN" button to select setting programs. And then, press "ENTER" button to confirm the selection or ESC button to exit.

### Setting Programs:

Program	Description	Selectable option
00	Exit setting mode	Escape 00 ESC
01	Output source priority: To configure load power source priority	Solar first 01 SOL
		Utility first (default) 01 UTI
		SBU priority 01 SBU
02	Maximum charging current: To configure total charging current for solar and utility chargers. (Max. charging current = utility charging current + solar charging current)	Available options in 1KVA 12V model:
		10A 02 10A
		20A 02 20A
		30A 02 30 <sup>A</sup>
40A (default) 02 40 <sup>A</sup>		
50A 02 50 <sup>A</sup>		
60A 02 60 <sup>A</sup>		



02	<p>Maximum charging current: To configure total charging current for solar and utility chargers. (Max. charging current = utility charging current + solar charging current)</p>	Available options in 1KVA 24V and 1KVA/3KVA 48V models:	
		10A 02 10A	20A (default) 02 20A
		30A 02 30 A	40A 02 40 A
		Available options in 2-3KVA 24V models:	
		20A 02 20A	30A (default) 02 30A
		40A 02 40 A	50A 02 50 A
		60A 02 60 A	
02	<p>Maximum charging current: To configure total charging current for solar and utility chargers. (Max. charging current = utility charging current + solar charging current)</p>	Available options in 2-3KVA 24V/48V Plus models:	
		10A (Not available for 2-3KVA 24V Plus) 02 10 A	20A 02 20 A
		30A 02 30 A	40A 02 40 A
		50A 02 50 A	60A (default) 02 60 A
		70A 02 70 A	80A 02 80 A
		90A (Not available for 2-3KVA 48V Plus) 02 90 A	
		Available options in 4K/5K model	
		10A 02 10 A	20A 02 20 A
		30A 02 30 A	40A 02 40 A
		50A 02 50 A	60A (default) 02 60 A
		70A 02 70 A	80A 02 80 A

		90A 02 90 <sup>A</sup>	100A 02 100 <sup>A</sup>
		110A 02 110 <sup>A</sup>	120A 02 120 <sup>A</sup>
		130A 02 130 <sup>A</sup>	140A 02 140 <sup>A</sup>
03	AC input voltage range	Appliances (default) 03 APL	If selected, acceptable AC input voltage range will be within 90-280VAC.
		UPS 03 UPS	If selected, acceptable AC input voltage range will be within 170-280VAC.
04	Power saving mode enable/disable	Saving mode disable (default) 04 SDS	If disabled, no matter connected load is low or high, the on/off status of inverter output will not be effected.
		Saving mode enable 04 SEN	If enabled, the output of inverter will be off when connected load is pretty low or not detected.
05	Battery type	AGM (default) 05 AGM	Flooded 05 FLD
		User-Defined 05 USE	If "User-Defined" is selected, battery charge voltage and low DC cut-off voltage can be set up in program 26, 27 and 29.
06	Auto restart when overload occurs	Restart disable (default) 06 Lfd	Restart enable 06 LfE
07	Auto restart when over temperature occurs	Restart disable (default) 07 tfd	Restart enable 07 tFE
09	Output frequency	50Hz (default) 09 50 <sup>Hz</sup>	60Hz 09 60 <sup>Hz</sup>









11	Maximum utility charging current	Available options in 1KVA 12V/ 24V model:	
		10A 11 10A	20A(default): 11 20A
		Available options in 2-3KVA 24V and 2-3KVA 24V Plus models:	
		20A 11 20A	30A (default) 11 30A
11	Maximum utility charging current	Available options in 1KVA/3KVA 48V and 2-3KVA 48V Plus models:	
		10A 11 10A	15A(default): 11 15A
		Available options in 4KVA/5KVA models:	
		2A 11 2A	10A 11 10A
		20A 11 20A	30A (default) 11 30A
		40A 11 40A	50A 11 50A
		60A 11 60A	
12	Setting voltage point back to utility source when selecting "SBU priority" or "Solar first" in program 01.	Available options in 12V model:	
		11.0V 12 BATT 11.0v	11.3V 12 BATT 11.3v
		11.5V (default) 12 BATT 11.5v	11.8V 12 BATT 11.8v
		12.0V 12 BATT 12.0v	12.3V 12 BATT 12.3v
		12.5V 12 BATT 12.5v	12.8V 12 BATT 12.8v

12	Setting voltage point back to utility source when selecting "SBU priority" or "Solar first" in program 01.	Available options in 24V models:			
		22.0V 12 <sup>BATT</sup> 22.0 <sub>v</sub>	22.5V 12 <sup>BATT</sup> 22.5 <sub>v</sub>		
		23.0V (default) 12 <sup>BATT</sup> 23.0 <sub>v</sub>	23.5V 12 <sup>BATT</sup> 23.5 <sub>v</sub>		
		24.0V 12 <sup>BATT</sup> 24.0 <sub>v</sub>	24.5V 12 <sup>BATT</sup> 24.5 <sub>v</sub>		
		25.0V 12 <sup>BATT</sup> 25.0 <sub>v</sub>	25.5V 12 <sup>BATT</sup> 25.5 <sub>v</sub>		
		Available options in 48V models:			
		44V 12 <sup>BATT</sup> 44 <sub>v</sub>	45V 12 <sup>BATT</sup> 45 <sub>v</sub>		
		46V (default) 12 <sup>BATT</sup> 46 <sub>v</sub>	47V 12 <sup>BATT</sup> 47 <sub>v</sub>		
		48V 12 <sup>BATT</sup> 48 <sub>v</sub>	49V 12 <sup>BATT</sup> 49 <sub>v</sub>		
		50V 12 <sup>BATT</sup> 50 <sub>v</sub>	51V 12 <sup>BATT</sup> 51 <sub>v</sub>		
		12	Setting voltage point back to utility source when selecting "SBU priority" or "Solar first" in program 01.	Below options only available for the model with 64VDC maximum charging voltage	
				52V 12 <sup>BATT</sup> 52 <sub>v</sub>	53V 12 <sup>BATT</sup> 53 <sub>v</sub>
54V 12 <sup>BATT</sup> 54 <sub>v</sub>	55V 12 <sup>BATT</sup> 55 <sub>v</sub>				

12	Setting voltage point back to utility source when selecting "SBU priority" or "Solar first" in program 01.	56V 12 <sup>BATT</sup> 56 <sup>v</sup>	57V 12 <sup>BATT</sup> 57 <sup>v</sup>
13	Setting voltage point back to battery mode when selecting "SBU priority" or "Solar first" in program 01.	Available options in 12V model:	
		Battery fully charged 13 <sup>BATT</sup> FUL	12.0V 13 <sup>BATT</sup> 12.0 <sup>v</sup>
		12.3V 13 <sup>BATT</sup> 12.3 <sup>v</sup>	12.5V 13 <sup>BATT</sup> 12.5 <sup>v</sup>
		12.8V 13 <sup>BATT</sup> 12.8 <sup>v</sup>	13.0V 13 <sup>BATT</sup> 13.0 <sup>v</sup>
		13.3V 13 <sup>BATT</sup> 13.3 <sup>v</sup>	13.5V (default) 13 <sup>BATT</sup> 13.5 <sup>v</sup>
		13.8V 13 <sup>BATT</sup> 13.8 <sup>v</sup>	14.0V 13 <sup>BATT</sup> 14.0 <sup>v</sup>
		14.3V 13 <sup>BATT</sup> 14.3 <sup>v</sup>	14.5V 13 <sup>BATT</sup> 14.5 <sup>v</sup>
		Available options in 24V models:	
		Battery fully charged 13 <sup>BATT</sup> FUL	24V 13 <sup>BATT</sup> 24.0 <sup>v</sup>
		24.5V 13 <sup>BATT</sup> 24.5 <sup>v</sup>	25V 13 <sup>BATT</sup> 25.0 <sup>v</sup>
		25.5V 13 <sup>BATT</sup> 25.5 <sup>v</sup>	26V 13 <sup>BATT</sup> 26.0 <sup>v</sup>
		26.5V 13 <sup>BATT</sup> 26.5 <sup>v</sup>	27V (default) 13 <sup>BATT</sup> 27.0 <sup>v</sup>



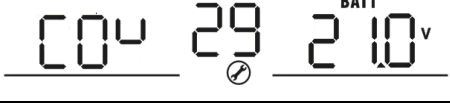



13	Setting voltage point back to battery mode when selecting "SBU priority" or "Solar first" in program 01.	27.5V 13 <sup>BATT</sup> 27.5 v	28V 13 <sup>BATT</sup> 28.0 v
		28.5V 13 <sup>BATT</sup> 28.5 v	29V 13 <sup>BATT</sup> 29.0 v
		Available options in 48V models:	
		Battery fully charged 13 <sup>BATT</sup> FUL	48V 13 <sup>BATT</sup> 48.0 v
		49V 13 <sup>BATT</sup> 49.0 v	50V 13 <sup>BATT</sup> 50.0 v
		51V 13 <sup>BATT</sup> 51.0 v	52V 13 <sup>BATT</sup> 52.0 v
		53V 13 <sup>BATT</sup> 53.0 v	54V (default) 13 <sup>BATT</sup> 54.0 v
		55V 13 <sup>BATT</sup> 55.0 v	56V 13 <sup>BATT</sup> 56.0 v
		57V 13 <sup>BATT</sup> 57.0 v	58V 13 <sup>BATT</sup> 58.0 v
		Below options only available for the model with 64VDC maximum charging voltage	
		59V 13 <sup>BATT</sup> 59 v	60V 13 <sup>BATT</sup> 60 v
		61V 13 <sup>BATT</sup> 61 v	62V 13 <sup>BATT</sup> 62 v
		63V 13 <sup>BATT</sup> 63 v	64V 13 <sup>BATT</sup> 64 v

16	Charger source priority: To configure charger source priority	If this inverter/charger is working in Line, Standby or Fault mode, charger source can be programmed as below:	
		Solar first 16 C50 ⊗	Solar energy will charge battery as first priority. Utility will charge battery only when solar energy is not available.
		Utility first (default for 1K~3K) 16 CUE ⊗	Utility will charge battery as first priority. Solar energy will charge battery only when utility power is not available.
		Solar and Utility (default for 4K/5K) 16 SNU ⊗	Solar energy and utility will charge battery at the same time.
		Only Solar 16 O50 ⊗	Solar energy will be the only charger source no matter utility is available or not.
		If this inverter/charger is working in Battery mode or Power saving mode, only solar energy can charge battery. Solar energy will charge battery if it's available and sufficient.	
18	Alarm control	Alarm on (default) 18 60N ⊗	Alarm off 18 60F ⊗
19	Auto return to default display screen	Return to default display screen (default) 19 ESP ⊗	If selected, no matter how users switch display screen, it will automatically return to default display screen (Input voltage /output voltage) after no button is pressed for 1 minute.
		Stay at latest screen 19 FEP ⊗	If selected, the display screen will stay at latest screen user finally switches.
20	Backlight control	Backlight on (default) 20 LON ⊗	Backlight off 20 LOF ⊗
22	Beeps while primary source is interrupted	Alarm on (default) 22 AON ⊗	Alarm off 22 AOF ⊗
23	Overload bypass: When enabled, the unit will transfer to line mode if overload occurs in battery mode.	Bypass disable (default) 23 byd ⊗	Bypass enable 23 byE ⊗
25	Record Fault code	Record enable 25 FEN ⊗	Record disable (default) 25 FdS ⊗

26	Bulk charging voltage (C.V voltage)	12V model default setting: 14.1V 
		24V model default setting: 28.2V 
		48V model default setting: 56.4V 
		If self-defined is selected in program 5, this program can be set up. Setting range is from 12.0V to 14.6V for 12V model, 24.0V to 29.2V for 24V model and 48.0V to 58.4V for 48V model. For the model with 64V maximum charging voltage, the setting range is from 48.0V to 64.0V. Increment of each click is 0.1V.
27	Floating charging voltage	12V model default setting: 13.5V 
		24V model default to 27.0V 
		48V model default setting: 54.0V 
		If self-defined is selected in program 5, this program can be set up. Setting range is from 12.0V to 14.6V for 12V model, 24.0V to 29.2V for 24V model, 48.0V to 58.4V for 48V model. For the model with 64V maximum charging voltage, the setting range is from 48.0V to 64.0V. Increment of each click is 0.1V.
29	Low DC cut-off voltage	12V model default setting: 10.5V 
		24V model default setting: 21.0V 
		48V model default setting: 42.0V 

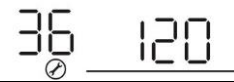

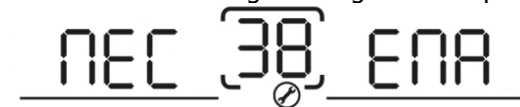
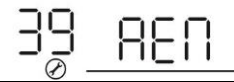
		If self-defined is selected in program 5, this program can be set up. Setting range is from 10.0V to 12.0V for 12V model, 20.0V to 24.0V for 24V model, 40.0V to 48.0V for 48V model. For the model with 64V maximum charging voltage, the setting range is from 40.0V to 54.0V. Increment of each click is 0.1V. Low DC cut-off voltage will be fixed to setting value no matter what percentage of load is connected.	
31	Solar power balance: When enabled, solar input power will be automatically adjusted according to connected load power. (Only available for 4KVA/5KVA model)	Solar power balance enable (Default): 31 5bE	If selected, solar input power will be automatically adjusted according to the following formula: Max. input solar power = Max. battery charging power + Connected load power.
		Solar power balance disable: 31 5bd	If selected, the solar input power will be the same to max. battery charging power no matter how much loads are connected. The max. battery charging power will be based on the setting current in program 02. (Max. solar power = Max. battery charging power)
32	Bulk charging time (C.V stage) (Only available for 4KVA/5KVA model)	Automatically (Default): 32 AUT	If selected, inverter will judge this charging time automatically.
		5 min 32 5	The setting range is from 5 min to 900 min. Increment of each click is 5 min.
		900 min 32 900	
If "USE" is selected in program 05, this program can be set up.			
33	Battery equalization	Battery equalization 33 EEN	Battery equalization disable (default) 33 EdS
		If "Flooded" or "User-Defined" is selected in program 05, this program can be set up.	
34	Battery equalization voltage	1K default setting: 14.6V. Setting range is from 12V ~ 14.6V. Increment of each click is 0.1V. EV 34 BATT 14.6 <sup>v</sup>	
		2KVA/3KVA default setting: 29.2V. Setting range is from 24V ~ 29.2V. Increment of each click is 0.1V. EV 34 BATT 29.2 <sup>v</sup>	

34	Battery equalization voltage	<p>4KVA/5KVA default setting: 58.4V. Setting range is from 48V ~ 58.4V. Increment of each click is 0.1V.</p> 	
		<p>For 4KVA/5KVA with 64V maximum charging voltage, default setting is 64V. Setting range is from 48V ~ 64V. Increment of each click is 0.1V.</p> 	
35	Battery equalized time	<p>60min (default)</p> 	<p>Setting range is from 5min to 900min. Increment of each click is 5min.</p>
36	Battery equalized timeout	<p>120min (default)</p> 	<p>Setting range is from 5min to 900 min. Increment of each click is 5 min.</p>
37	Equalization interval	<p>30days (default)</p> 	<p>Setting range is from 0 to 90 days. Increment of each click is 1 day</p>
38	<p>Allow neutral and grounding of AC output is connected together: When enabled, inverter can deliver signal to trigger grounding box to short neutral and grounding</p>	<p>Disable: Neutral and grounding of AC output is disconnected. (Default)</p>  <p>Enable: Neutral and grounding of AC output is connected.</p>  <p>This function is only available when the inverter is working with external grounding box. Only when the inverter is working in battery mode, it will trigger grounding box to connect neutral and grounding of AC output.</p>	
39	Equalization activated immediately	<p>Enable</p> 	<p>Disable (default)</p> 
		<p>If equalization function is enabled in program 33, this program can be set up. If "Enable" is selected in this program, it's to activate battery equalization immediately and LCD main page will shows "E9". If "Disable" is selected, it will cancel equalization function until next activated equalization time arrives based on program 37 setting. At this time, "E9" will not be shown in LCD main page.</p>	

## Display Setting





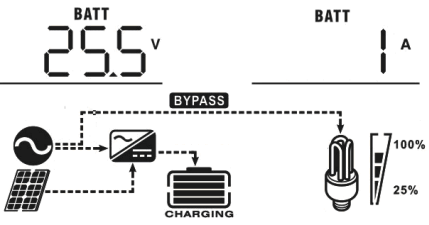
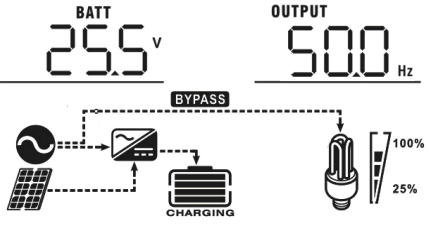
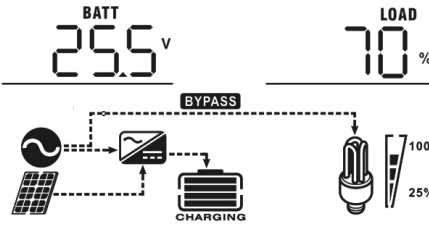
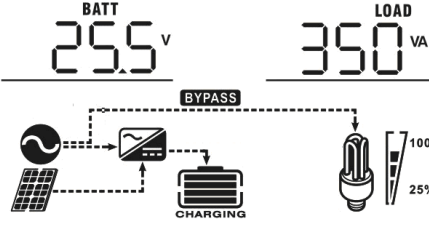
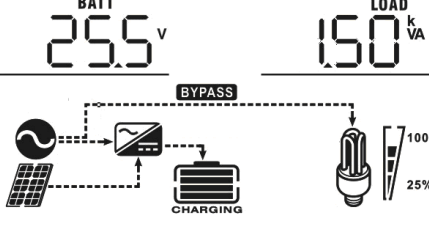

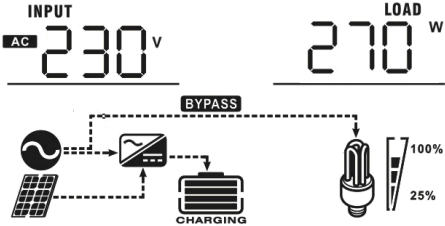
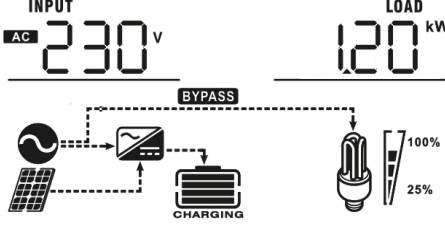
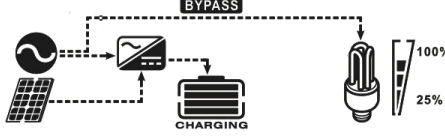
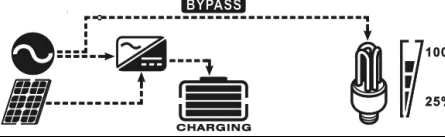

The LCD display information will be switched in turns by pressing "UP" or "DOWN" key. The selectable information is switched as below order: input voltage, input frequency, PV voltage, MPPT charging current, MPPT charging power, battery voltage, output voltage, output frequency, load percentage, load in VA, load in Watt, DC discharging current, main CPU Version and second CPU Version.

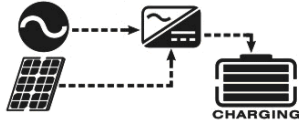
Selectable information	LCD display
Input voltage/Output voltage (Default Display Screen)	<p>Input Voltage=230V, output voltage=230V</p>
Input frequency	<p>Input frequency=50Hz</p>
PV voltage	<p>PV voltage=60V</p>
MPPT Charging current	<p>Current <math>\geq 10A</math></p> <p>Current &lt; 10A</p>
MPPT Charging power	<p>MPPT charging power=500W</p>

Battery voltage/ DC discharging current	<p>Battery voltage=25.5V, discharging current=1A</p> 
Output frequency	<p>Output frequency=50Hz</p> 
Load percentage	<p>Load percent=70%</p> 
Load in VA	<p>When connected load is lower than 1kVA, load in VA will present xxxVA like below chart.</p>  <p>When load is larger than 1kVA (<math>\geq 1\text{kVA}</math>), load in VA will present x.xkVA like below chart.</p> 

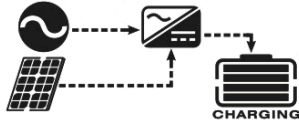
<p>Load in Watt</p>	<p>When load is lower than 1kW, load in W will present xxxW like below chart.</p>  <p>When load is larger than 1kW (<math>\geq 1\text{kW}</math>), load in W will present x.xkW like below chart.</p> 
<p>Main CPU version checking</p>	<p>Main CPU version 00014.04</p> 
<p>Secondary CPU version checking</p>	<p>Secondary CPU version 00003.03</p> 

# Operating Mode Description

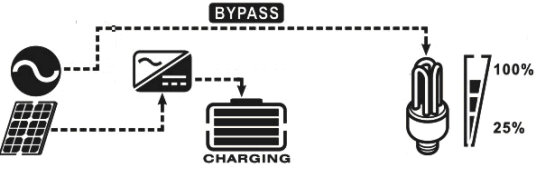
Operation mode	Description	LCD display
<p>Standby mode / Power saving mode</p> <p><b>Note:</b></p> <p>*Standby mode: The inverter is not turned on yet but at this time, the inverter can charge battery without AC output.</p> <p>*Power saving mode: If enabled, the output of inverter will be off when connected load is pretty low or not detected.</p>	<p>No output is supplied by the unit but it still can charge batteries.</p>	<p>Charging by utility and PV energy.</p> 
		<p>Charging by utility.</p> 
		<p>Charging by PV energy.</p> 
		<p>No charging.</p> 
<p>Fault mode</p> <p>Note:</p> <p>*Fault mode: Errors are caused by inside circuit error or external reasons such as over temperature, output short circuited and so on.</p>	<p>PV energy and utility can charge batteries.</p>	<p>Charging by utility and PV energy.</p> 
		<p>Charging by utility. (Only available in 1K/2K/3K model)</p> 
		<p>Charging by PV energy.</p> 
		<p>No charging.</p> 
<p>Line Mode</p>	<p>The unit will provide output power from the mains. It will also charge the battery at line mode.</p>	<p>Charging by PV energy</p> 
		<p>Charging by utility.</p>

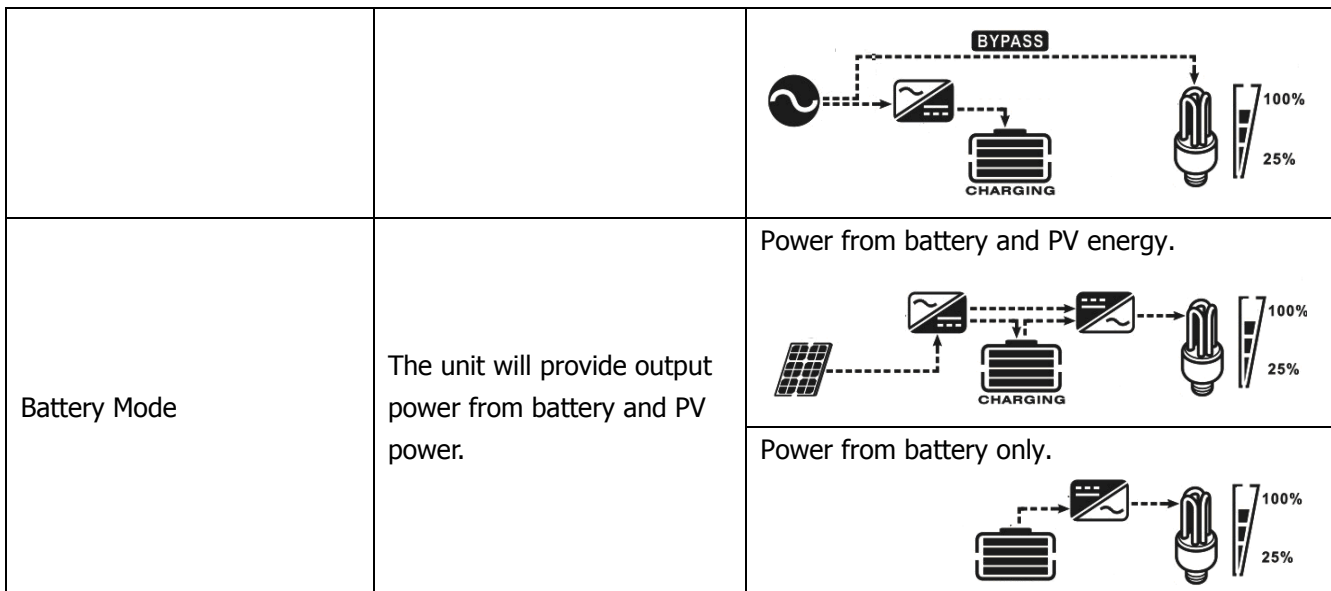









## Fault Reference Code

Fault Code	Fault Event	Icon on
01	Fan is locked when inverter is off.	
02	Over temperature	
03	Battery voltage is too high	
04	Battery voltage is too low	
05	Output short circuited or over temperature is detected by internal converter components.	
06	Output voltage is abnormal. (For 1K/2K/3K model) Output voltage is too high. (For 4K/5K model)	
07	Overload time out	
08	Bus voltage is too high	
09	Bus soft start failed	
11	Main relay failed	
51	Over current or surge	
52	Bus voltage is too low	
53	Inverter soft start failed	
55	Over DC voltage in AC output	
56	Battery connection is open	
57	Current sensor failed	
58	Output voltage is too low	

**NOTE: Fault codes 51, 52, 53, 55, 56, 57 and 58 are only available in 4K/5K model.**

## Warning Indicator

Warning Code	Warning Event	Audible Alarm	Icon flashing
01	Fan is locked when inverter is on.	Beep three times every second	
03	Battery is over-charged	Beep once every second	
04	Low battery	Beep once every second	
07	Overload	Beep once every 0.5 second	
10	Output power derating	Beep twice every 3 seconds	
12	Solar charger stops due to low battery.		
13	Solar charger stops due to high PV voltage.		
14	Solar charger stops due to overload.		
E9	Battery equalization		



# BATTERY EQUALIZATION

Equalization function is added into charge controller. It reverses the buildup of negative chemical effects like stratification, a condition where acid concentration is greater at the bottom of the battery than at the top. Equalization also helps to remove sulfate crystals that might have built up on the plates. If left unchecked, this condition, called sulfation, will reduce the overall capacity of the battery. Therefore, it's recommended to equalize battery periodically.

- **How to Apply Equalization Function**

You must enable battery equalization function in monitoring LCD setting program 33 first. Then, you may apply this function in device by either one of following methods:

1. Setting equalization interval in program 37.
2. Active equalization immediately in program 39.

- **When to Equalize**

In float stage, when the setting equalization interval (battery equalization cycle) is arrived, or equalization is active immediately, the controller will start to enter Equalize stage.

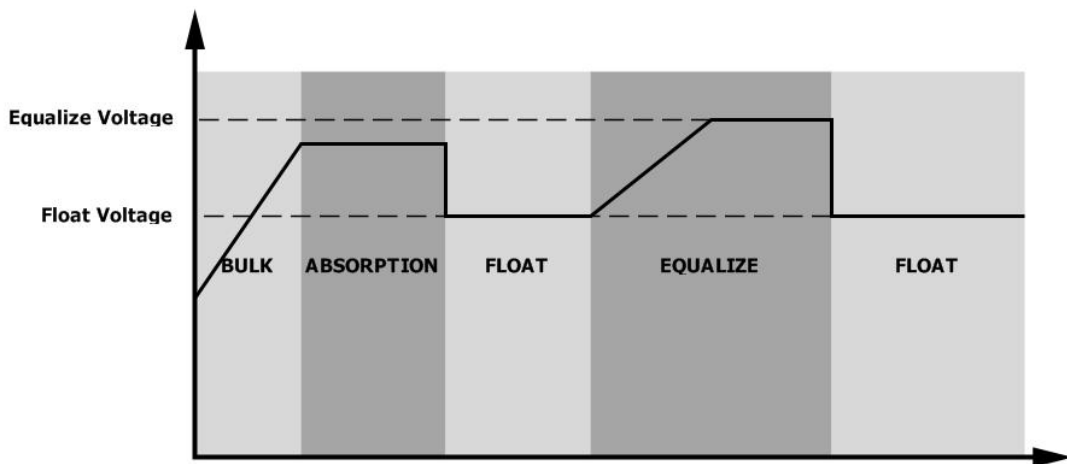

- **Equalize charging time and timeout**

In Equalize stage, the controller will supply power to charge battery as much as possible until battery voltage raises to battery equalization voltage. Then, constant-voltage regulation is applied to maintain battery voltage at the battery equalization voltage. The battery will remain in the Equalize stage until setting battery equalized time is arrived.

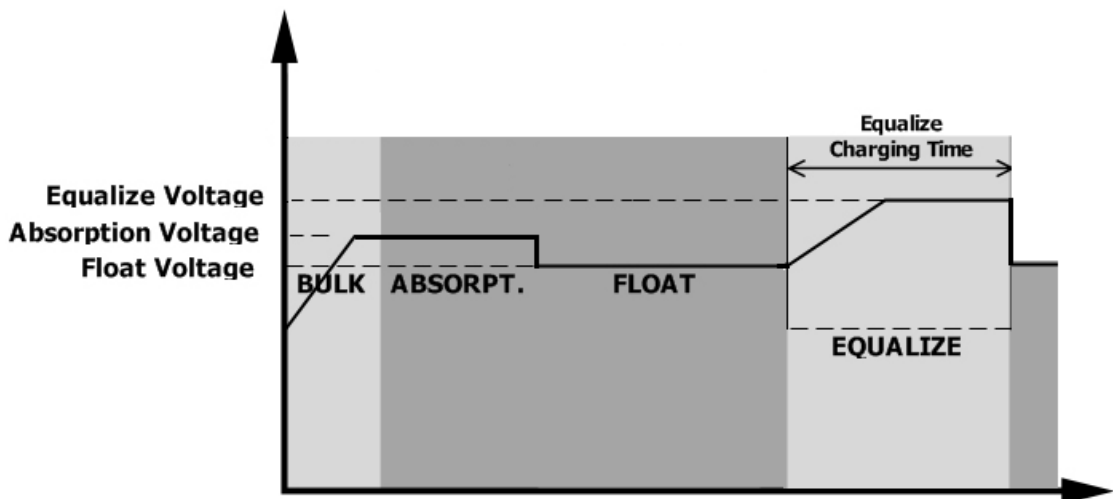

However, in Equalize stage, when battery equalized time is expired and battery voltage doesn't rise to battery equalization voltage point, the charge controller will extend the battery equalized time until battery voltage achieves battery equalization voltage. If battery voltage is still lower than battery equalization voltage when battery equalized timeout setting is over, the charge controller will stop equalization and return to float stage.

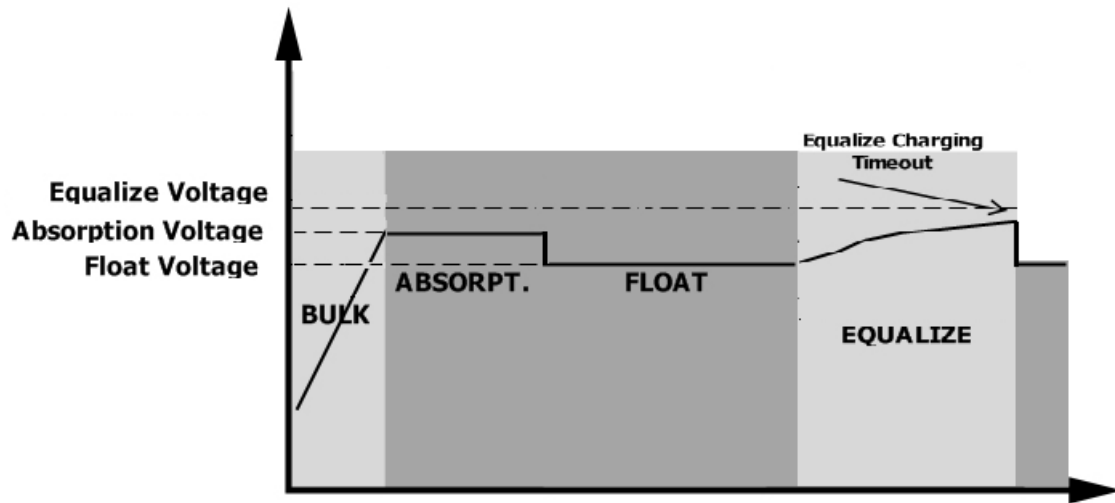

# SPECIFICATIONS

Table 1 Line Mode Specifications

INVERTER MODEL	<b>1KVA 12V</b> <b>1KVA 24V</b> <b>2KVA 24V</b> <b>3KVA 24V</b> <b>1KVA 48V</b> <b>3KVA 48V</b>	<b>2KVA 24V Plus</b> <b>3KVA 24V Plus</b> <b>2KVA 48V Plus</b> <b>3KVA 48V Plus</b>	<b>4KVA</b> <b>5KVA</b>
<b>Input Voltage Waveform</b>	Sinusoidal (utility or generator)		
<b>Nominal Input Voltage</b>	230Vac		
<b>Low Loss Voltage</b>	170Vac±7V (UPS) 90Vac±7V (Appliances)		
<b>Low Loss Return Voltage</b>	180Vac±7V (UPS); 100Vac±7V (Appliances)		
<b>High Loss Voltage</b>	280Vac±7V		
<b>High Loss Return Voltage</b>	270Vac±7V		
<b>Max AC Input Voltage</b>	300Vac		
<b>Nominal Input Frequency</b>	50Hz / 60Hz (Auto detection)		
<b>Low Loss Frequency</b>	40±1Hz		
<b>Low Loss Return Frequency</b>	42±1Hz		
<b>High Loss Frequency</b>	65±1Hz		
<b>High Loss Return Frequency</b>	63±1Hz		
<b>Output Short Circuit Protection</b>	Line mode: Circuit Breaker Battery mode: Electronic Circuits		
<b>Efficiency (Line Mode)</b>	>95% ( Rated R load, battery full charged )		
<b>Transfer Time</b>	10ms typical (UPS); 20ms typical (Appliances)		
<b>Output power derating:</b> When AC input voltage drops to 95V or 170V depending on models, the output power will be derated.			

Table 2 Inverter Mode Specifications

<b>INVERTER MODEL</b>	<b>1KVA 12V</b>	<b>1KVA 24V 2KVA 24V 3KVA 24V 2KVA 24V Plus 3KVA 24V Plus</b>	<b>1KVA 48V 3KVA 48V 2KVA 48V Plus 3KVA 48V Plus</b>	<b>4KVA 5KVA</b>
<b>Rated Output Power</b>	1KVA/1KW	1KVA/1KW 2KVA/2KW 3KVA/3KW	1KVA/1KW 2KVA/2KW 3KVA/3KW	4KVA/4KW 5KVA/5KW
<b>Output Voltage Waveform</b>	Pure Sine Wave			
<b>Output Voltage Regulation</b>	230Vac±5%			
<b>Output Frequency</b>	60Hz or 50Hz			
<b>Peak Efficiency</b>	90%			
<b>Overload Protection</b>	5s@≥150% load; 10s@110%~150% load			
<b>Surge Capacity</b>	2* rated power for 5 seconds			
<b>Nominal DC Input Voltage</b>	12Vdc	24Vdc	48Vdc	
<b>Cold Start Voltage</b>	11.5Vdc	23.0Vdc	46.0Vdc	
<b>Low DC Warning Voltage</b>				
@ load < 20%	11.0Vdc	22.0Vdc	44.0Vdc	
@ 20% ≤ load < 50%	10.7Vdc	21.4Vdc	42.8Vdc	
@ load ≥ 50%	10.1Vdc	20.2Vdc	40.4Vdc	
<b>Low DC Warning Return Voltage</b>				
@ load < 20%	11.5Vdc	23.0Vdc	46.0Vdc	
@ 20% ≤ load < 50%	11.2Vdc	22.4Vdc	44.8Vdc	
@ load ≥ 50%	10.6Vdc	21.2Vdc	42.4Vdc	
<b>Low DC Cut-off Voltage</b>				
@ load < 20%	10.5Vdc	21.0Vdc	42.0Vdc	
@ 20% ≤ load < 50%	10.2Vdc	20.4Vdc	40.8Vdc	
@ load ≥ 50%	9.6Vdc	19.2Vdc	38.4Vdc	
<b>High DC Recovery Voltage</b>	14.5Vdc	29Vdc	58Vdc	58Vdc or 62Vdc
<b>High DC Cut-off Voltage</b>	15.5Vdc	31Vdc	62Vdc	60Vdc or 66Vdc
<b>No Load Power Consumption</b>	<15W	<25W		<50W
<b>Saving Mode Power Consumption</b>	<5W	<10W		<15W

Table 3 Charge Mode Specifications

Utility Charging Mode					
<b>INVERTER MODEL</b>	<b>1KVA 12V</b>	<b>1KVA 24V</b>	<b>2KVA 24V 3KVA 24V 2KVA 24V Plus 3KVA 24V Plus</b>	<b>1KVA 48V 3KVA 48V 2KVA 48V Plus 3KVA 48V Plus</b>	<b>4KVA 5KVA</b>
<b>Charging Current (UPS) @ Nominal Input Voltage</b>	10/20A		20/30A	10/15A	2/10A/ 20/30A/ 40/50/60A
<b>Bulk Charging Voltage</b>	<b>Flooded Battery</b>	14.6	29.2	58.4	
	<b>AGM / Gel Battery</b>	14.1	28.2	56.4	
<b>Floating Charging Voltage</b>	13.5Vdc	27Vdc	54Vdc	54Vdc or 64Vdc	
<b>Overcharge Protection</b>	15.5Vdc	31Vdc	60Vdc	66Vdc	
<b>Charging Algorithm</b>	3-Step				
<b>Charging Curve</b>					

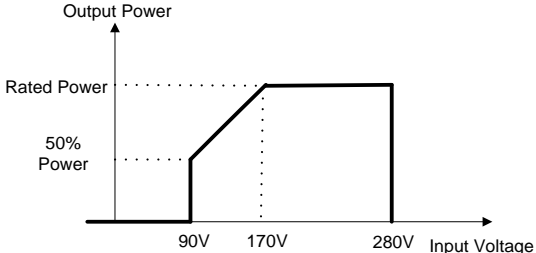
Solar Charging Mode						
INVERTER MODEL	1KVA 12V	1KVA 24V 2KVA 24V 3KVA 24V	1KVA 48V 3KVA 48V	2KVA 24V Plus 3KVA 24V Plus	2KVA 48V Plus 3KVA 48V Plus	4KVA 5KVA
Rated Power	500W	600W	900W	1500W	3000W	4000W
Efficiency	98.0% max.					
Max. PV Array Open Circuit Voltage	102Vdc	75Vdc	102Vdc	145Vdc		
PV Array MPPT Voltage Range	15~80Vdc	30~66Vdc	60~88Vdc	30~115Vdc	60~115Vdc	
Min battery voltage for PV charge	8.5Vdc	17Vdc	34Vdc	17Vdc	34Vdc	
Standby Power Consumption	2W					
Battery Voltage Accuracy	+/-0.3%					
PV Voltage Accuracy	+/-2V					
Charging Algorithm	3-Step					
Joint Utility and Solar Charging						
Max Charging Current	60Amp	1K: 45Amp 2K/3K: 55Amp	33Amp	90Amp	75Amp	140Amp
Default Charging Current	40Amp	1K: 20Amp 2K/3K: 30Amp	20Amp	60 Amp	60 Amp	60Amp

Table 4 General Specifications

INVERTER MODEL	1KVA 12V 1KVA 24V 1KVA 48V	2KVA 24V	3KVA 24V 3KVA 48V	2KVA 24V Plus 3KVA 24V Plus 2KVA 48V Plus 3KVA 48V Plus	4KVA	5KVA
Safety Certification	CE					
Operating Temperature Range	0°C to 55°C					
Storage temperature	-15°C~ 60°C					
Humidity	5% to 95% Relative Humidity (Non-condensing)					
Dimension (D*W*H), mm	100 x 272 x 355			140 x 295 x 479	120 x 295 x 468	
Net Weight, kg	6.8	7.0	7.4	11.5	11	

# TROUBLE SHOOTING

Problem	LCD/LED/Buzzer	Explanation / Possible cause	What to do
Unit shuts down automatically during startup process.	LCD/LEDs and buzzer will be active for 3 seconds and then complete off.	The battery voltage is too low (<1.91V/Cell)	1. Re-charge battery. 2. Replace battery.
No response after power on.	No indication.	1. The battery voltage is far too low. (<1.4V/Cell) 2. Battery polarity is connected reversed.	1. Check if batteries and the wiring are connected well. 2. Re-charge battery. 3. Replace battery.
Mains exist but the unit works in battery mode.	Input voltage is displayed as 0 on the LCD and green LED is flashing.	Input protector is tripped	Check if AC breaker is tripped and AC wiring is connected well.
	Green LED is flashing.	Insufficient quality of AC power. (Shore or Generator)	1. Check if AC wires are too thin and/or too long. 2. Check if generator (if applied) is working well or if input voltage range setting is correct. (UPS→Appliance)
	Green LED is flashing.	Set "Solar First" as the priority of output source.	Change output source priority to Utility first.
When the unit is turned on, internal relay is switched on and off repeatedly.	LCD display and LEDs are flashing	Battery is disconnected.	Check if battery wires are connected well.
Buzzer beeps continuously and red LED is on.	Fault code 07	Overload error. The inverter is overload 110% and time is up.	Reduce the connected load by switching off some equipment.
	Fault code 05	Output short circuited.	Check if wiring is connected well and remove abnormal load.
		Temperature of internal converter component is over 120°C. (Only available for 1-3KVA models.)	Check whether the air flow of the unit is blocked or whether the ambient temperature is too high.
	Fault code 02	Internal temperature of inverter component is over 100°C.	
	Fault code 03	Battery is over-charged.	Return to repair center.
		The battery voltage is too high.	Check if spec and quantity of batteries are meet requirements.
	Fault code 01	Fan fault	Replace the fan.
	Fault code 06/58	Output abnormal (Inverter voltage below than 190Vac or is higher than 260Vac)	1. Reduce the connected load. 2. Return to repair center
	Fault code 08/09/53/57	Internal components failed.	Return to repair center.
	Fault code 51	Over current or surge.	Restart the unit, if the error happens again, please return to repair center.
	Fault code 52	Bus voltage is too low.	
Fault code 55	Output voltage is unbalanced.		
Fault code 56	Battery is not connected well or fuse is burnt.	If the battery is connected well, please return to repair center.	